

WINDOW CASEMENT

Weight kg/M. 0.679

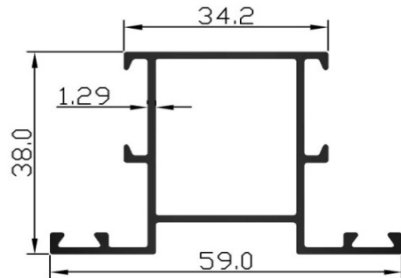

Section No. 420-0002

Weight kg/M. 0.744

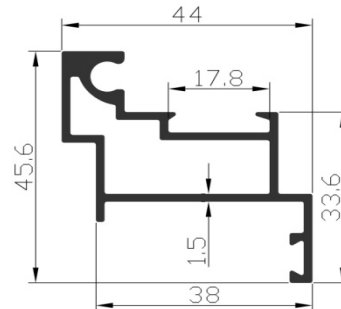

Section No. 420-0008

Weight kg/M. 0.126

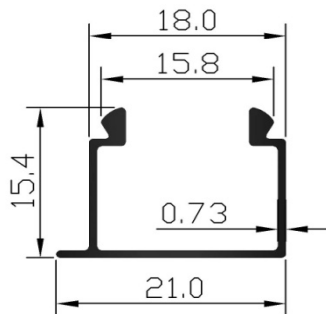

Section No. 420-0003

Weight kg/M. 0.542

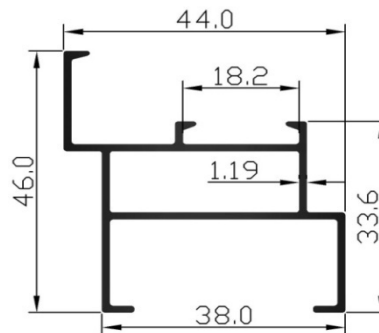

Section No. 420-0004

Weight kg/M. 0.554

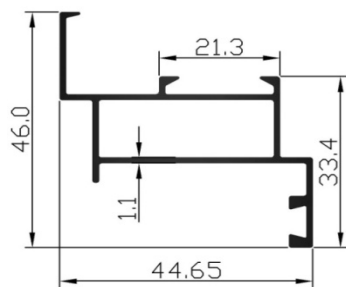

Section No. 420-0001

Weight kg/M. 0.486

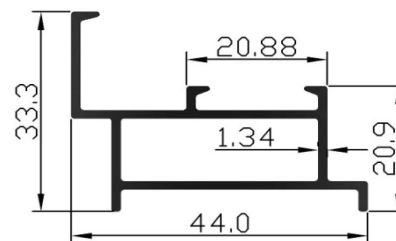

Section No. 420-0005

WINDOW CASEMENT

Weight kg/M. 0.748

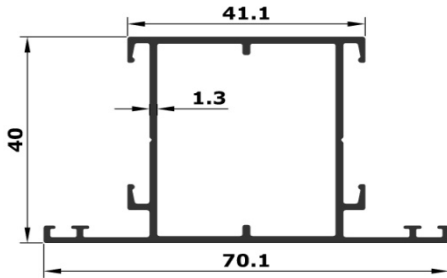

Section No. 420-0020

Weight kg/M. 0.708

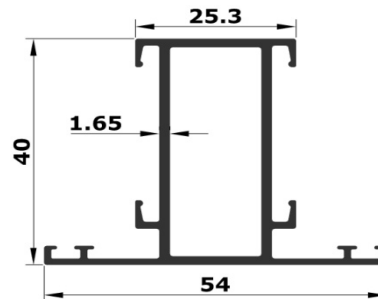

Section No. 420-0021

Weight kg/M. 0.561

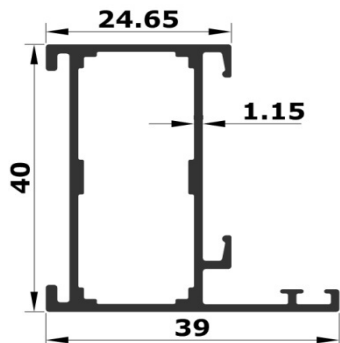

Section No. 420-0022

Weight kg/M. 0.767

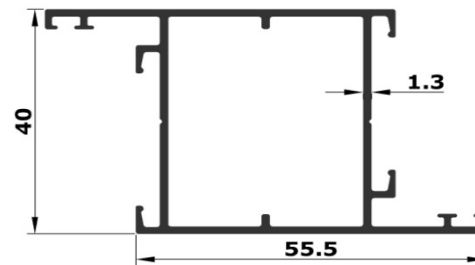

Section No. 420-0027

Weight kg/M. 0.941

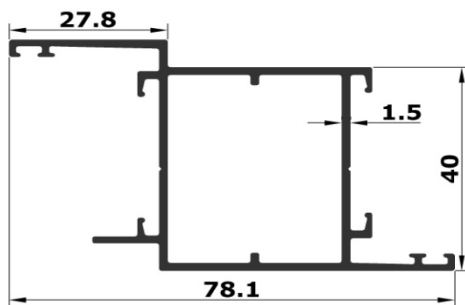

Section No. 430-0017

Weight kg/M. 1.298

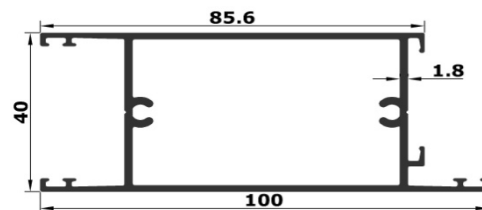

Section No. 430-0018

WINDOW CASEMENT

Weight kg/M. 0.302

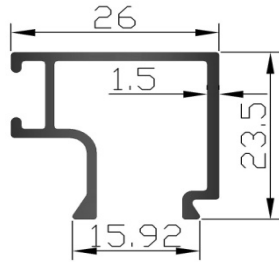

Section No. 430-0014

Weight kg/M. 0.109

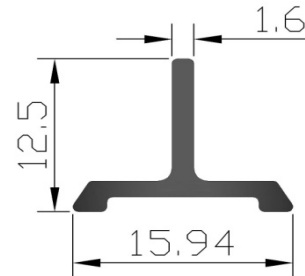

Section No. 420-0014

Weight kg/M. 1.562

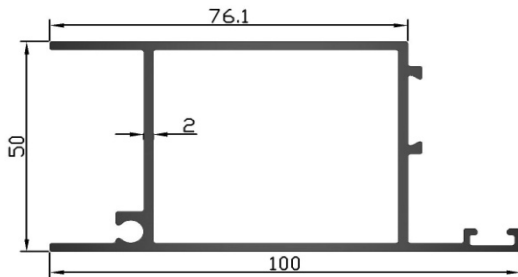

Section No. 420-0015

Weight kg/M. 1.269

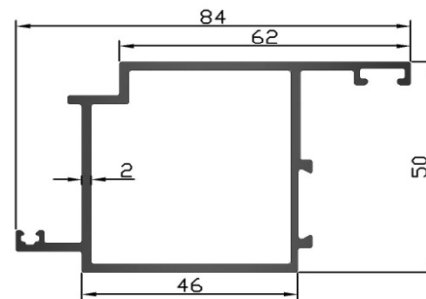

Section No. 420-0016

Weight kg/M. 0.666

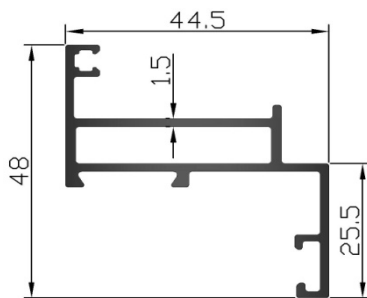

Section No. 420-0017

Weight kg/M. 1.422

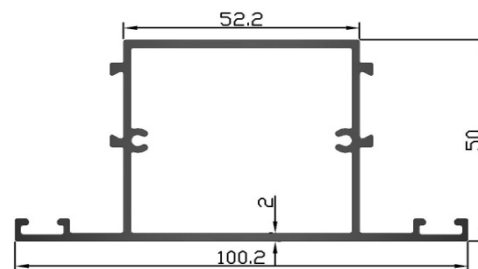

Section No. 420-0018

WINDOW CASEMENT

Weight kg/M. | 1.146

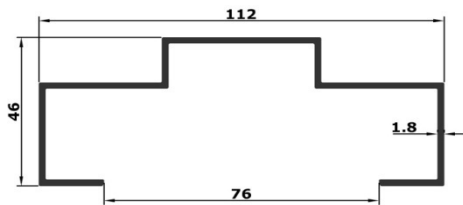

Section No. | 420-0007

Weight kg/M. | 0.189

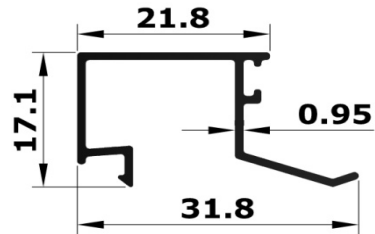

Section No. | 420-0026

Weight kg/M. | 0.554

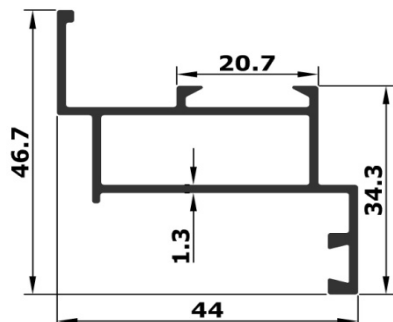

Section No. | 420-0006

Weight kg/M. | 0.539

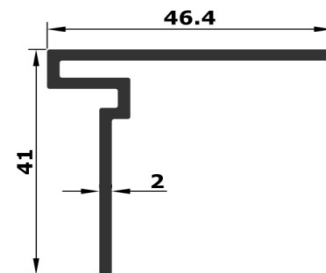

Section No. | 420-0019

Weight kg/M. | 0.409

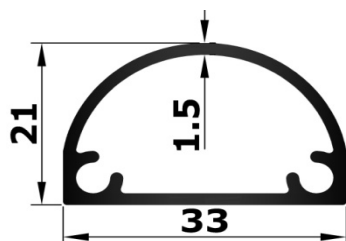

Section No. | 420-0028*

Weight kg/M. | 1.211

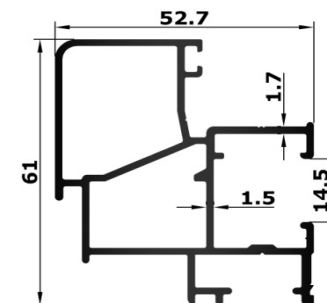

Section No. | 420-0029*

WINDOW CASEMENT

Weight kg/M. | 0.195

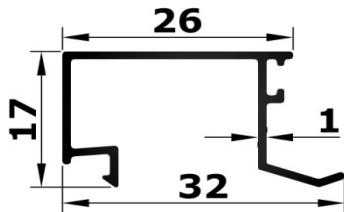

Section No. | 420-0030

Weight kg/M. | 0.927

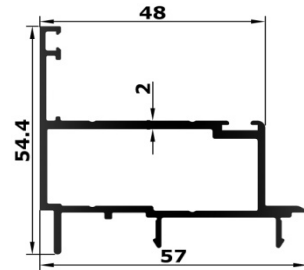

Section No. | 420-0031

Weight kg/M. | 0.762

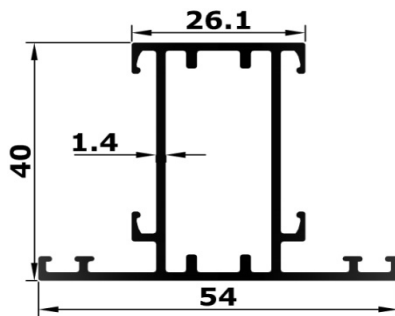

Section No. | 420-0032

Weight kg/M. | 0.669

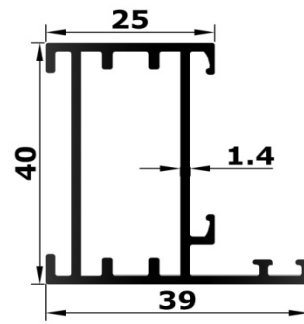

Section No. | 420-0033

Weight kg/M. | 1.243

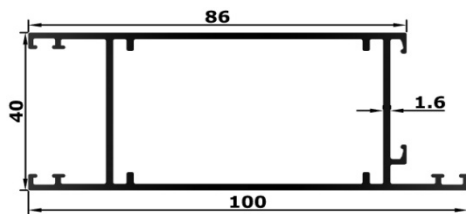

Section No. | 420-0034

Weight kg/M. | 0.955

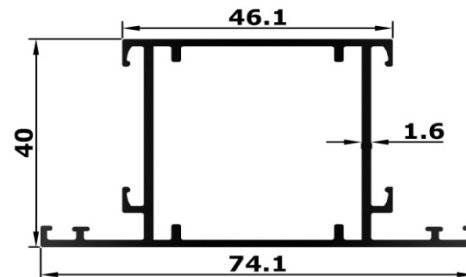

Section No. | 420-0035

WINDOW CASEMENT

Weight kg/M. | 0.945

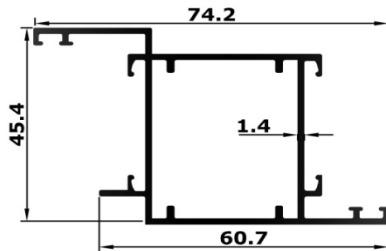

Section No. | 420-0036

Weight kg/M. | 0.247

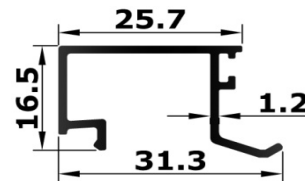

Section No. | 420-0037

Weight kg/M. | 1.151

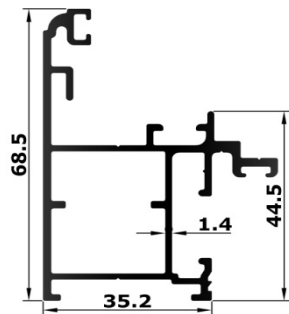

Section No. | 420-0038

Weight kg/M. | 1.141

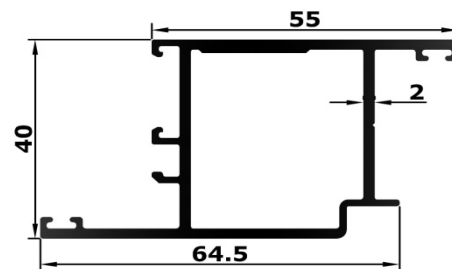

Section No. | 420-0039

Weight kg/M. | 1.14

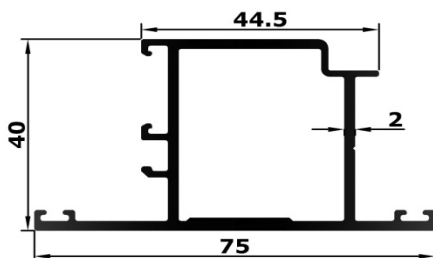

Section No. | 420-0040

Weight kg/M. | 0.564

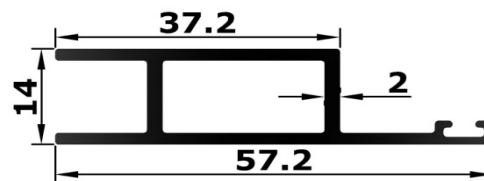

Section No. | 420-0041